

Forets marteaux Burins

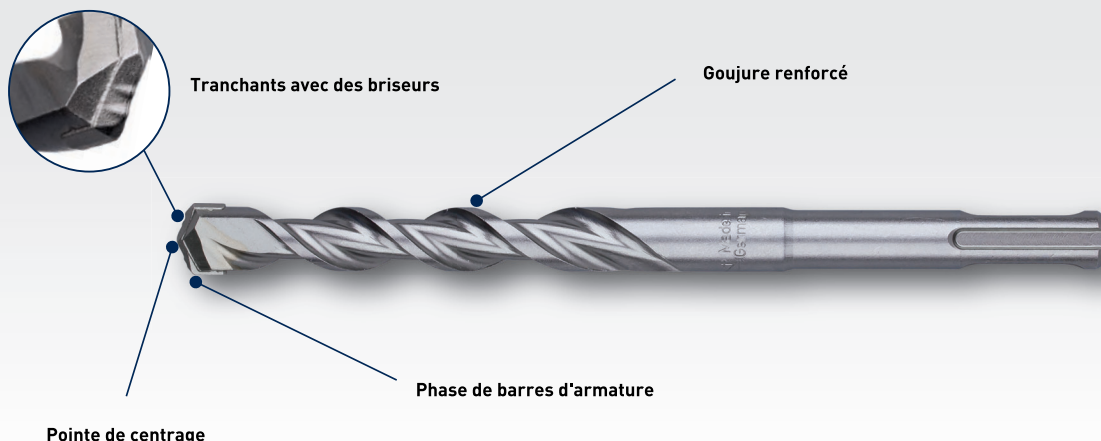

LISTE DES MARQUES ET MODÈLES SELON EMMANCHMENT

Emmanchement		Marques	
SDS-plus	(ø10mm)	Convient pour tous les machines avec SDS-plus	
SDS-max	(ø18mm)	Convient pour tous les machines avec SDS-max (Hilti TE-Y)	
		Atlas Copco	HEX 19mm PB 14 D
		AEG	HEX 19mm 6385, 900B, 900S, 900KS, 900XS, 1400B
		Casals	HEX 19mm Tornado
		Kango	HEX 19mm 5335
		Milwaukee	ø16,5 x 35 / HEX 19mm PB10H, PH5H, PH11H, PH40H, PHE50H, PH24DD, PH350, PH38, PHD26, PHD38, PHD 350D, 430S, 501S, 637S, 950S, 950KS, 950XS, 9788S, 5311, 5312, 5316, 6317, 5347, 5348, 5352, 5353 ø19 x 65 / HEX 21mm P86C, PB10C, PB14C, PH11C 900, 900K, 900X, 928, 950, 950K, 950X, 1400, 1400K, 1900K ø13 x 45 / HEX 17mm PHSF
		Bosch	HEX 19mm 11032, USH10 (11305), 11310, 11312, HSH10 (12312) ø16,5 x 35 / HEX 19mm UBH6/35, UBH6/35D, UBH12/50 (11209) GBH7.45DE (11214), USH6 GSH27, USH27 (11304), HSH28 (12314)
		Black & Decker	HEX 28mm SH60K
		DeWalt	HEX 19mm DW558K, D25941K, D25940K
		ELU	ø16,5 x 35 / HEX 19mm BH41K, BH41EK, BH46EK
		Hitachi	HEX 19mm DH50SA1 ø16,5 x 35 / HEX 19mm DH38YF, DH38YA, DH50SR, DH40FA/FB ø19 x 65 / HEX 21mm DH50SA, DH50SA1, H555A ø24 x 55 / HEX 30mm H65SB, H70SA HEX 28mm 1165SD ø13 x 45 / HEX 17mm H41SA
		ITW Spit	HEX 19mm 400
		Kango	HEX 19mm 638, 900 B, 900 KS, 900S, 900 XS, 1400 B
		Makita	HEX 19mm HMT 200B, HM 1200 B, HM 1242 C, HM 1211 B ø16,5 x 35 / HEX 19mm HR3850B, HR3520B, HR404C, HR5060, HM0810B, HM1242C, HM1140C HEX 28mm HM1500B, HM1800, HM1303B ø19 x 65 / HEX 21mm HM1200K, HR3580K, HR5000K ø12 x 40mm HK1800, HK1800L, HK1810, HM1810 ø13 x 45 / HEX 17mm HR3520, HR3850, HM0810, 8035NB, THM1130C ø16 x 45 / HEX 20,5mm HM1200, 8900S ø24 x 55 / HEX 30mm HM1300, HM1303, HM1204, HM1400, HM1500, 8900N
		Milwaukee	5335
		Ryobi	HEX 19mm CH 486 K ø24 x 55 / HEX 30mm CH-500K ø16,5 x 35 / 19mm CH465 / 1138
		Spit	HEX 19mm 400
		Wacker	HEX 19 x 82mm EH8/220, EHB10/220, EHUB10Y/220, EHU8Y/220, EHL8Y, BH814



Exécution: Les forets assurent, grâce à leur affûtage, une pénétration rapide et une extraction optimale des matériaux. La résistance de la pointe au carbure optimisée par son design et sa rigidité offre une durabilité sans rivale même dans le béton armé. Le système AVS apporte de l'énergie directement vers la pointe du foret.

d ₁	l ₁	l ₂	pcs/UD	Ref.	€ / UD
4,0	110	50	1	200.0400	5,06
4,0	160	100	1	200.0401	6,82
5,0	110	50	1	200.0500	4,02
5,0	140	80	1	200.0501	5,69
5,0	160	100	1	200.0502	4,76
5,0	210	150	1	200.0503	7,91
5,0	260	200	1	200.0503L	10,03
5,0	310	250	1	200.0504	13,08
5,0	400	340	1	200.0506	26,92
5,0	450	390	1	200.0507	28,46
5,5	110	50	1	200.0550	4,44
5,5	160	100	1	200.0551	5,11
5,5	210	150	1	200.0552	8,37
5,5	260	200	1	200.0553	9,77
5,5	310	250	1	200.0554	14,55
5,5	410	350	1	200.0555	24,36
5,5	460	400	1	200.0556	28,16
5,5	600	540	1	200.0558	35,73
6,0	110	50	1	200.0600	3,99
6,0	160	100	1	200.0601	4,51
6,0	210	150	1	200.0602	6,99
6,0	260	200	1	200.0603	9,11
6,0	310	250	1	200.0603L	14,28
6,0	460	400	1	200.0604	21,60
6,5	110	50	1	200.0650	4,71
6,5	160	100	1	200.0651	5,85
6,5	210	150	1	200.0652	8,32
6,5	260	200	1	200.0653	10,07
6,5	310	250	1	200.0654	11,67
6,5	400	340	1	200.0655	28,62
6,5	450	390	1	200.0656	33,39
7,0	110	50	1	200.0700	5,06
7,0	160	100	1	200.0701	6,21
7,0	210	150	1	200.0702	7,96
7,0	250	190	1	200.0703	10,72
8,0	110	50	1	200.0800	5,24
8,0	160	100	1	200.0801	5,42
8,0	210	150	1	200.0802	6,99
8,0	260	200	1	200.0803	8,53
8,0	310	250	1	200.0804	12,24
8,0	400	340	1	200.0804L	19,98

d ₁	l ₁	l ₂	pcs/UD	Ref.	€ / UD
8,0	460	400	1	200.0805	21,48
8,0	610	550	1	200.0806	27,36
8,0	1000	950	1	200.0807	95,53
8,5	260	200	1	200.0853	14,73
9,0	160	100	1	200.0901	7,39
9,0	210	150	1	200.0902	8,85
9,5	160	100	1	200.0951	9,61
9,5	310	250	1	200.0953	25,79
10,0	110	50	1	200.1000	5,85
10,0	160	100	1	200.1001	6,37
10,0	210	150	1	200.1002	8,19
10,0	260	200	1	200.1003	9,77
10,0	310	250	1	200.1004	12,50
10,0	350	290	1	200.1004L	16,39
10,0	450	400	1	200.1005	19,63
10,0	600	540	1	200.1006	27,24
10,0	800	740	1	200.1006L	32,71
10,0	1000	940	1	200.1007	70,90
11,0	160	100	1	200.1100	9,04
11,0	210	160	1	200.1101	10,46
11,0	260	210	1	200.1102	12,63
11,0	310	260	1	200.1103	14,83
12,0	160	110	1	200.1200	7,45
12,0	210	160	1	200.1201	9,77
12,0	260	210	1	200.1202	11,89
12,0*	360	310	1	200.1202M	19,53
12,0	310	260	1	200.1202L	17,89
12,0	450	400	1	200.1203	22,11
12,0	600	550	1	200.1204	29,55
12,0	1000	950	1	200.1205	71,49
13,0	160	100	1	200.1300	10,35
13,0	210	160	1	200.1301	13,83
13,0	260	210	1	200.1302	16,72
13,0	310	260	1	200.1302L	20,29
13,0	450	400	1	200.1303	25,23
14,0	160	110	1	200.1400	11,38
14,0	210	160	1	200.1401	13,70
14,0	260	210	1	200.1402	15,35
14,0	310	260	1	200.1403	17,06
14,0	450	400	1	200.1404	25,30
14,0	600	550	1	200.1405	35,38

d ₁	l ₁	l ₂	pcs/UD	Ref.	€/UD
14,0	1000	950	1	200.1406	76,18
15,0	160	110	1	200.1500	13,63
15,0	210	160	1	200.1501	15,65
15,0	260	210	1	200.1502	16,33
15,0	450	400	1	200.1503	28,99
16,0	160	110	1	200.1600	14,57
16,0	210	160	1	200.1601	17,19
16,0	260	210	1	200.1601L	19,95
16,0	310	260	1	200.1602	24,16
16,0	450	400	1	200.1603	33,26
16,0	600	550	1	200.1604	35,75
16,0	800	750	1	200.1605	54,34
16,0	1000	950	1	200.1606	79,79
17,0	210	160	1	200.1700	22,69
17,0	450	400	1	200.1703	49,40
18,0	200	150	1	200.1800	26,50
18,0	250	200	1	200.1801	32,38
18,0	300	250	1	200.1802	35,83
18,0	450	400	1	200.1803	36,46
18,0	600	550	1	200.1804	64,83
18,0	1000	950	1	200.1805	94,32
19,0	200	150	1	200.1900	31,01

d ₁	l ₁	l ₂	pcs/UD	Ref.	€/UD
19,0	450	400	1	200.1902	40,13
20,0	200	150	1	200.2000	32,29
20,0	300	250	1	200.2002	37,59
20,0	450	400	1	200.2003	41,27
20,0	600	550	1	200.2004	53,49
20,0	1000	950	1	200.2005	100,82
22,0	250	200	1	200.2201	43,03
22,0	300	250	1	200.2202	51,12
22,0	450	400	1	200.2203	51,17
22,0	600	550	1	200.2204	71,95
22,0	1000	950	1	200.2205	133,11
23,0	250	200	1	200.2301	53,75
24,0	250	200	1	200.2400	50,00
24,0	450	400	1	200.2402	59,31
24,0	600	550	1	200.2403	87,55
25,0	250	200	1	200.2500	50,00
25,0	450	400	1	200.2502	64,83
25,0	600	550	1	200.2503	84,76
25,0	1000	950	1	200.2505	127,53
26,0	250	200	1	200.2600	54,34
26,0	450	400	1	200.2602	67,14

201

Foret marteau, SDS-plus, V-Breaker, dans box



Exécution: Les forets assurent, grâce à leur affûtage, une pénétration rapide et une extraction optimale des matériaux. La résistance de la pointe au carbure optimisée par son design et sa rigidité offre une durabilité sans rivale même dans le béton armé. La système AVS apporte de l'énergie directement vers la pointe du foret.

d ₁	l ₁	l ₂	pcs/UD	Ref.	€/UD
4,0	110	50	10	201.0400	49,08
4,0	160	100	10	201.0401	65,03
5,0	110	50	10	201.0500	39,98
5,0	140	80	10	201.0501	54,02
5,0	160	100	10	201.0502	45,39
5,0	210	150	10	201.0503	74,99
5,0	310	250	10	201.0504	128,34
5,5	110	50	10	201.0550	43,03
5,5	160	100	10	201.0551	49,64
5,5	210	150	10	201.0552	79,44
5,5	260	200	10	201.0553	93,18
5,5	310	250	10	201.0554	151,87
6,0	110	50	10	201.0600	37,87
6,0	160	100	10	201.0601	42,48
6,0	210	150	10	201.0602	67,85
6,0	260	200	10	201.0603	86,61
6,5	110	50	10	201.0650	44,68
6,5	160	100	10	201.0651	55,72
6,5	210	150	10	201.0652	78,88
6,5	260	200	10	201.0653	95,97
6,5	310	250	10	201.0654	116,16
7,0	110	50	10	201.0700	47,94
7,0	160	100	10	201.0701	59,01
7,0	210	150	10	201.0702	75,56

d ₁	l ₁	l ₂	pcs/UD	Ref.	€/UD
8,0	110	50	10	201.0800	49,69
8,0	160	100	10	201.0801	51,17
8,0	210	150	10	201.0802	67,85
8,0	260	200	10	201.0803	82,74
8,0	310	250	10	201.0804	118,94
9,0	160	100	10	201.0901	72,67
9,0	210	150	10	201.0902	86,93
9,5	160	100	10	201.0951	93,18
10,0	110	50	10	201.1000	56,81
10,0	160	100	10	201.1001	59,69
10,0	210	150	10	201.1002	79,44
10,0	260	200	10	201.1003	94,83
10,0	310	250	10	201.1004	122,24
11,0	160	110	10	201.1101	89,22
11,0	210	160	10	201.1102	102,99
11,0	260	210	10	201.1103	124,41
11,0	310	260	10	201.1104	148,51
12,0	160	110	10	201.1200	71,08
12,0	210	160	10	201.1201	92,92
12,0	260	210	10	201.1202	112,86
12,0	310	260	10	201.1204	170,80
14,0	160	110	10	201.1400	109,05
14,0	210	160	10	201.1401	129,45
14,0	260	210	10	201.1402	145,55

900

Jeu de forets marteaux, SDS-plus, V-Breaker, dans cassette en ABS

ROTEC®



Exécution: Les forets assurent, grâce à leur affûtage, une pénétration rapide et une extraction optimale des matériaux. La résistance de la pointe au carbure optimisée par son design et sa rigidité offre une durabilité sans rivale même dans le béton armé. Le système AVS apporte de l'énergie directement vers la pointe du foret.

Description	Type	Contenu	pcs/UD	Ref.	€/UD
7 pcs - jeu de forets marteaux, SDS-plus, V-Breaker	200	ø5, 6 et 8x110 / 1 pc de chaque ø6, 8, 10 et 12x160 / 1 pc de chaque	1	900.1010K	46,27

Jeu de forets marteaux, SDS-plus, V-Breaker, dans coffret en plastique

ROTEC®



Exécution: Les forets assurent, grâce à leur affûtage, une pénétration rapide et une extraction optimale des matériaux. La résistance de la pointe au carbure optimisée par son design et sa rigidité offre une durabilité sans rivale même dans le béton armé. Le système AVS apporte de l'énergie directement vers la pointe du foret.

Description	Type	Contenu	pcs/UD	Ref.	€/UD
40 pcs - jeu de forets marteaux, SDS-plus, V-Breaker	200	ø6x110 / 5 pcs de chaque ø6, 8, 10 et 12x160 / 5 pcs de chaque ø8, 10 et 12x210 / 5 pcs de chaque	1	900.1015	276,81

200

Adaptateur

ROTEC®

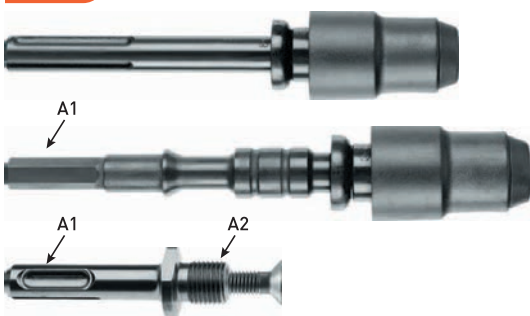

Nr.	A ₁	A ₂	pcs/UD	Ref.	€/UD
1	SDS-max	SDS-plus	1	200.9001	138,22
2	HEX 13	SDS-plus	1	200.9003	133,05
3	SDS-plus	1/2 - 20 UNF	1	200.9007	14,31

Rallonge, SDS-plus

ROTEC®

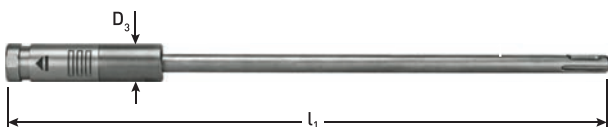

Exécution: Rallonge universelle SDS-plus avec système de changement rapide pour forets marteaux, trépan pour béton, burins, etc.
Application: Pour percer dans des espaces étroits ou difficiles d'accès.

Description	l ₁	D ₃	pcs/UD	Ref.	€/UD
Rallonge SDS+	300	21	1	200.9010	237,30
Rallonge SDS+	450	21	1	200.9011	244,75

Quattro

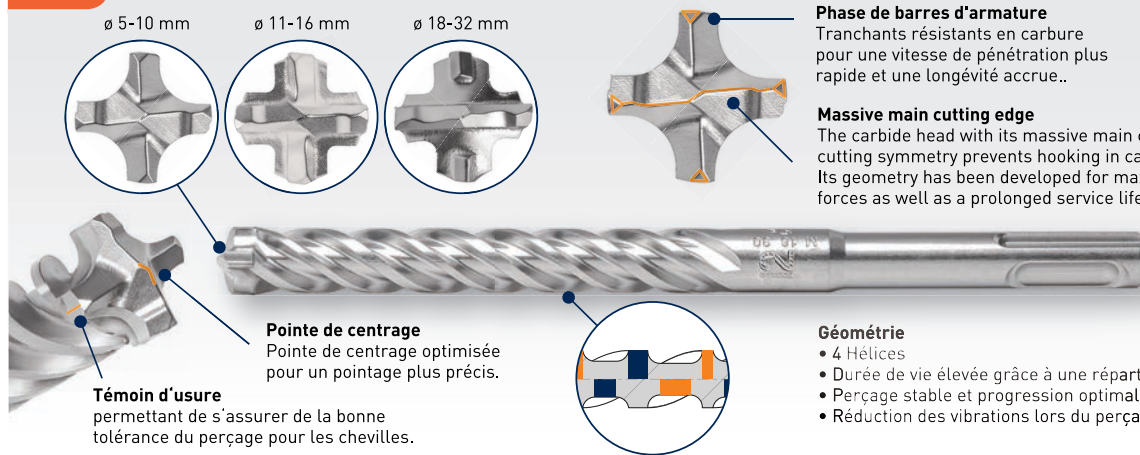

Phase de barres d'armature
Tranchants résistants en carbure pour une vitesse de pénétration plus rapide et une longévité accrue..

Massive main cutting edge
The carbide head with its massive main cutting edge and its 4x90° cutting symmetry prevents hooking in case of reinforcement strikes. Its geometry has been developed for maximum impact and torsion forces as well as a prolonged service life.

- Géométrie**
- 4 Hélices
 - Durée de vie élevée grâce à une répartition des charges égale
 - Perçage stable et progression optimale
 - Réduction des vibrations lors du perçage

Pointe de centrage
Pointe de centrage optimisée pour un pointage plus précis.

Témoin d'usure
permettant de s'assurer de la bonne tolérance du perçage pour les chevilles.



Exécution: Tranchants résistants au carbure pour une vitesse de pénétration plus rapide et une longévité accrue. Les 4 taillants symétriques au carbure garantissent un trou circulaire, net et précis. Plus performant ils ne coincent pas même dans les fers à béton. Corps de gros diamètre pour une meilleure résistance à la flexion et pour absorber les vibrations. L'hélice quadruple et symétrique assure une évacuation optimale des poussières.

Application: L'usure est uniforme. Pour le béton, béton armé, pierre naturelle, brique...

d ₁	l ₁	l ₂	pcs/UD	Ref.	€/UD
5,0	115	50	1	202.0500	8,32
5,0	165	100	1	202.0502	8,96
5,0	215	150	1	202.0503	15,59
5,0	265	200	1	202.0504	17,54
5,0	315	250	1	202.0505	24,94
5,5	115	50	1	202.0550	8,34
5,5	165	100	1	202.0551	8,98
6,0	115	50	1	202.0600	8,05
6,0	165	100	1	202.0601	8,66
6,0	215	150	1	202.0602	11,29
6,0	265	200	1	202.0603	13,94
6,0	315	250	1	202.0604	19,31
6,5	165	100	1	202.0651	11,43
6,5	215	150	1	202.0652	15,39
6,5	265	200	1	202.0653	20,48
6,5	315	250	1	202.0654	24,87
7,0	115	50	1	202.0700	10,82
7,0	165	100	1	202.0701	11,48
7,0	215	150	1	202.0702	16,15
8,0	115	50	1	202.0800	9,42
8,0	165	100	1	202.0801	9,95
8,0	215	150	1	202.0802	11,34
8,0	265	200	1	202.0803	13,35
8,0	315	250	1	202.0804	18,89
8,0	365	300	1	202.0804L	25,75
8,0	465	400	1	202.0805	31,03
9,0	165	100	1	202.0901	11,46
9,0	265	200	1	202.0903	14,67
10,0	115	50	1	202.1000	10,12
10,0	165	100	1	202.1001	11,01
10,0	215	150	1	202.1002	12,58
10,0	265	200	1	202.1003	14,69
10,0	315	250	1	202.1004	18,15
10,0	365	300	1	202.1004L	27,33
10,0	455	390	1	202.1005	33,93
10,0	600	540	1	202.1006	40,43
10,0	1000	940	1	202.1007	102,86
11,0	160	110	1	202.1101	16,85
11,0	210	160	1	202.1102	20,10
11,0	260	210	1	202.1103	23,46
11,0	310	260	1	202.1104	30,87
12,0	160	110	1	202.1200	12,24
12,0	210	160	1	202.1201	14,91
12,0	260	210	1	202.1202	16,93
12,0	310	260	1	202.1203	23,23

d ₁	l ₁	l ₂	pcs/UD	Ref.	€/UD
12,0	450	400	1	202.1204	34,89
12,0	600	550	1	202.1205	48,94
12,0	1000	950	1	202.1207	109,09
13,0	160	110	1	202.1300	16,01
13,0	210	160	1	202.1301	26,77
13,0	260	210	1	202.1302	30,19
13,0*	310	260	1	202.1303	32,27
14,0	160	110	1	202.1400	17,26
14,0	210	160	1	202.1401	23,10
14,0	260	210	1	202.1402	27,24
14,0	310	260	1	202.1403	28,68
14,0	450	400	1	202.1404	35,99
14,0	600	550	1	202.1405	53,79
14,0	1000	950	1	202.1407	112,17
15,0	160	110	1	202.1500	26,95
15,0	210	160	1	202.1501	30,45
15,0	260	210	1	202.1502	33,42
15,0	450	400	1	202.1503	45,20
16,0	160	110	1	202.1600	27,20
16,0	210	160	1	202.1600L	29,93
16,0	260	210	1	202.1601	43,77
16,0	310	260	1	202.1602	37,59
16,0	450	400	1	202.1603	54,04
16,0	600	550	1	202.1604	58,03
16,0	1000	950	1	202.1607	127,90
18,0	250	200	1	202.1801	49,47
18,0	450	400	1	202.1803	61,37
18,0	600	550	1	202.1804	84,27
20,0	250	200	1	202.2001	54,31
20,0	450	400	1	202.2003	68,78
20,0	600	550	1	202.2004	91,56
22,0	250	200	1	202.2201	62,82
22,0	450	400	1	202.2203	79,71
22,0	600	550	1	202.2204	109,74
24,0	250	200	1	202.2401	67,95
24,0	450	400	1	202.2402	85,84
25,0	250	200	1	202.2501	74,57
25,0	450	400	1	202.2502	93,85
26,0	450	400	1	202.2602	110,41
28,0	250	200	1	202.2801	84,47
28,0	450	400	1	202.2802	107,97
30,0	250	200	1	202.3001	93,50
30,0	450	400	1	202.3002	125,09
32,0	450	400	1	202.3202	137,00

202 Foret 4 taillants, SDS-plus, QUATTRO-X, dans box



Exécution: Tranchants résistants au carbure pour une vitesse de pénétration plus rapide et une longévité accrue. Les 4 taillants symétriques au carbure garantissent un trou circulaire, net et précis. Plus performant ils ne coincent pas même dans les fers à béton. Corps de gros diamètre pour une meilleure résistance à la flexion et pour absorber les vibrations. L'hélice quadruple et symétrique assure une évacuation optimale des poussières.

Application: L'usure est uniforme. Pour le béton, béton armé, pierre naturelle, brique...

d ₁	l ₁	l ₂	pcs/UD	Ref.	€ / UD
5,0	115	50	10	202.0500B	83,16
5,0	165	100	10	202.0502B	89,53
5,5	115	50	10	202.0550B	83,39
5,5	165	100	10	202.0551B	89,76
6,0	115	50	10	202.0600B	80,61
6,0	165	100	10	202.0601B	86,63
6,0	215	150	10	202.0602B	112,93
6,0	265	200	10	202.0603B	139,33
6,0	315	250	10	202.0604B	193,08
6,5	165	100	10	202.0651B	114,20
6,5	215	150	10	202.0652B	153,93
6,5	265	200	10	202.0653B	204,78
6,5	315	250	10	202.0654B	248,78
7,0	115	50	10	202.0700B	109,11
7,0	165	100	10	202.0701B	114,73
8,0	115	50	10	202.0800B	94,16
8,0	165	100	10	202.0801B	99,50
8,0	215	150	10	202.0802B	113,49
8,0	265	200	10	202.0803B	133,54

d ₁	l ₁	l ₂	pcs/UD	Ref.	€ / UD
8,0	315	250	10	202.0804B	188,78
9,0	165	100	10	202.0901B	114,90
9,0	265	200	10	202.0903B	150,74
10,0	115	50	10	202.1000B	101,24
10,0	165	100	10	202.1001B	110,03
10,0	215	150	10	202.1002B	125,89
10,0	265	200	10	202.1003B	146,86
10,0	315	250	10	202.1004B	181,50
11,0	160	110	10	202.1101B	169,34
11,0	210	160	10	202.1102B	201,00
12,0	160	110	10	202.1200B	122,32
12,0	210	160	10	202.1201B	149,18
12,0	260	210	10	202.1202B	169,21
12,0	310	260	10	202.1203B	237,27
14,0	160	110	10	202.1400B	174,54
14,0	210	160	10	202.1401B	231,07
14,0	260	210	10	202.1402B	274,91
14,0	310	260	10	202.1403B	290,55

900 Jeu de forets marteaux, SDS-plus, QUATTRO, dans cassette en ABS



Exécution: Tranchants résistants au carbure pour une vitesse de pénétration plus rapide et une longévité accrue. Les 4 taillants symétriques au carbure garantissent un trou circulaire, net et précis. Plus performant ils ne coincent pas même dans les fers à béton. Corps de gros diamètre pour une meilleure résistance à la flexion et pour absorber les vibrations. L'hélice quadruple et symétrique assure une évacuation optimale des poussières.

Application: L'usure est uniforme. Pour le béton, béton armé, pierre naturelle, brique...

Description	Type	Contenu	pcs/UD	Ref.	€ / UD
7 pcs - jeu de forets marteaux, SDS-plus, QUATTRO-X	202	ø5, 6 et 8x110 / 1 pc de chaque ø6, 8, 10 et 12x160 / 1 pc de chaque	1	900.1011K	72,91

Jeu de forets marteaux, SDS-plus, QUATTRO, dans coffret en plastique



Exécution: Tranchants résistants au carbure pour une vitesse de pénétration plus rapide et une longévité accrue. Les 4 taillants symétriques au carbure garantissent un trou circulaire, net et précis. Plus performant ils ne coincent pas même dans les fers à béton. Corps de gros diamètre pour une meilleure résistance à la flexion et pour absorber les vibrations. L'hélice quadruple et symétrique assure une évacuation optimale des poussières.

Application: L'usure est uniforme. Pour le béton, béton armé, pierre naturelle, brique...

Description	Type	Contenu	pcs/UD	Ref.	€ / UD
40 pcs - jeu de forets marteaux, SDS-plus, QUATTRO-X	202	ø6x110 / 5 pcs de chaque ø6, 8, 10 et 12x160 / 5 pcs de chaque ø8, 10 et 12x210 / 5 pcs de chaque	1	900.1016	450,55

203

Foret 2 taillants, SDS-max

ROTEC®

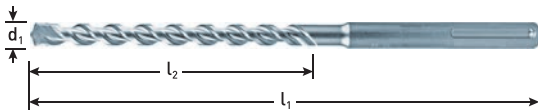

Exécution: Les forets assurent, grâce à leur affûtage, une pénétration rapide et une extraction optimale des matériaux. La résistance de la pointe au carbure optimisée par son design et sa rigidité offre une durabilité sans rivale même dans le béton armé. Système AVS transfère l'énergie directement vers la pointe du foret.

Application: L'usure est uniforme: Pour le béton, béton armé, pierre naturelle, brique...

d ₁	l ₁	l ₂	pcs/UD	Ref.	€/UD
12,0	340	200	1	203.1201	60,20
12,0	540	400	1	203.1202	75,72
12,0 *	740	600	1	203.1203	91,84
12,0 *	920	800	1	203.1204	115,46

d ₁	l ₁	l ₂	pcs/UD	Ref.	€/UD
14,0	340	200	1	203.1401	72,86
14,0	540	400	1	203.1402	81,08
15,0 *	340	200	1	203.1501	73,45
15,0 *	540	400	1	203.1502	84,48

* Article expiré, disponible jusqu'à épuisement des stocks

203

Foret 4 taillants, SDS-max, QUATTRO-X

ROTEC®

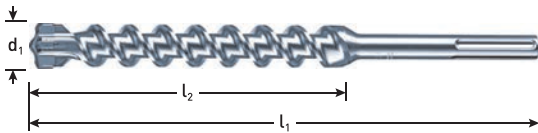

Exécution: Tranchants résistants au carbure pour une vitesse de pénétration plus rapide et une longévité accrue. Les 4 taillants symétriques au carbure garantissent un trou circulaire, net et précis. Plus performant ils ne coincent pas même dans les fers à béton. Corps de gros diamètre pour une meilleure résistance à la flexion et pour absorber les vibrations. L'hélice quadruple et symétrique assure une évacuation optimale des poussières.

Application: L'usure est uniforme: Pour le béton, béton armé, pierre naturelle, brique...

d ₁	l ₁	l ₂	pcs/UD	Ref.	€/UD
12,0	340	200	1	203.1211	65,67
12,0	540	400	1	203.1212	82,45
12,0	740	600	1	203.1213	100,28
14,0	340	200	1	203.1411	79,41
14,0	540	400	1	203.1412	88,57
14,0	940	800	1	203.1414	128,86
15,0	340	200	1	203.1511	80,42
15,0	540	400	1	203.1512	92,65
16,0	340	200	1	203.1601	77,43
16,0	540	400	1	203.1602	93,76
16,0	740	600	1	203.1603	115,02
16,0	940	800	1	203.1604	136,94
16,0	1320	1180	1	203.1605	260,98
18,0	340	200	1	203.1801	79,43
18,0	540	400	1	203.1802	94,77
18,0	740	600	1	203.1803	99,27
18,0	940	800	1	203.1804	111,69
18,0	1320	1180	1	203.1805	275,20
20,0	320	200	1	203.2001	80,76
20,0	520	400	1	203.2002	97,29
20,0	720	600	1	203.2003	128,04
20,0	920	800	1	203.2004	134,20
20,0	1320	1200	1	203.2005	276,00
22,0	320	200	1	203.2201	86,78
22,0	520	400	1	203.2202	101,07
22,0	720	600	1	203.2203	122,45
22,0	920	800	1	203.2204	146,64
22,0	1320	1200	1	203.2205	289,45
24,0	320	200	1	203.2401	93,76
24,0	520	400	1	203.2402	111,64
25,0	320	200	1	203.2501	95,73
25,0	520	400	1	203.2502	108,67
25,0	720	600	1	203.2503	129,50
25,0	920	800	1	203.2504	169,26

d ₁	l ₁	l ₂	pcs/UD	Ref.	€/UD
25,0	1320	1200	1	203.2505	316,29
26,0	520	400	1	203.2602	119,81
28,0	370	250	1	203.2801	110,21
28,0	570	450	1	203.2802	126,89
28,0	670	550	1	203.2803	165,28
28,0	920	800	1	203.2804	194,14
28,0	1320	1200	1	203.2805	331,34
30,0	370	250	1	203.3001	121,53
30,0	570	450	1	203.3002	146,64
30,0	720	600	1	203.3002L	198,82
30,0	920	800	1	203.3003	206,09
32,0	370	250	1	203.3201	125,98
32,0	570	450	1	203.3202	152,82
32,0	720	600	1	203.3202L	208,41
32,0	920	800	1	203.3203	220,93
32,0	1320	1200	1	203.3205	328,62
35,0	370	250	1	203.3501	140,17
35,0	570	450	1	203.3502	169,00
35,0	670	550	1	203.3503	197,24
35,0	920	800	1	203.3504	267,96
35,0	1320	1200	1	203.3505	353,89
37,0	370	250	1	203.3701	167,46
38,0	570	450	1	203.3802	204,53
38,0	720	600	1	203.3803	299,00
38,0	920	800	1	203.3804	314,88
40,0	370	250	1	203.4001	212,48
40,0	570	450	1	203.4002	251,13
40,0	720	600	1	203.4003	360,85
40,0	920	800	1	203.4004	326,60
40,0	1320	1200	1	203.4005	399,78
45,0	570	450	1	203.4502	299,63
45,0	920	800	1	203.4504	375,35
50,0	570	450	1	203.5002	340,99
52,0	570	450	1	203.5202	401,67

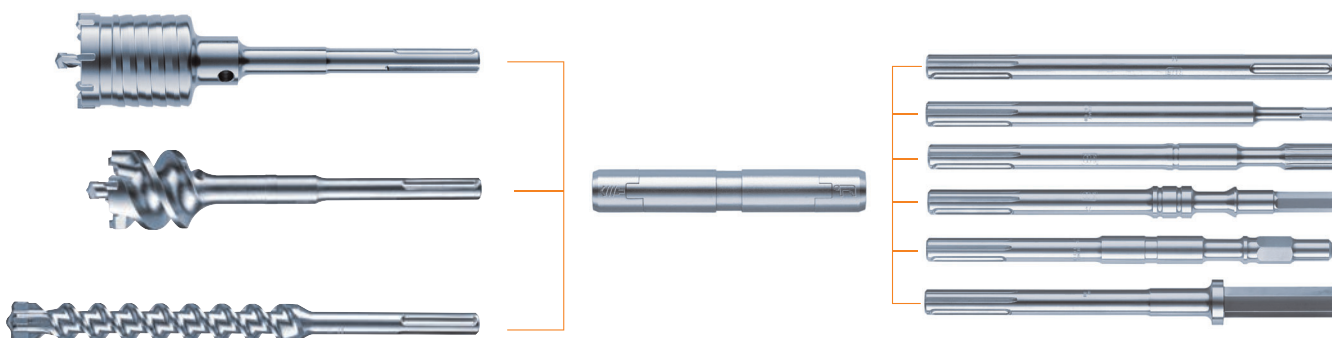

Les rallonges Dre-Connect permettent de combiner des outils SDS-max et avec tout autre emmanchement.

Avec ses deux emmanchements femelles SDS-max, le DreConnect permet une connexion sûre et rapide entre l'outil de perçage, la rallonge ou le porte-outil.

Deux "clics" seulement et l'outil a la longueur désirée.

Avec l'adaptateur Dre-Connect, il n'y a aucune perte d'énergie, contrairement aux systèmes existants. La totalité de la puissance du marteau est ainsi transmise dans la tête de l'outil de perçage.

Le DreConnect n'a aucun point de faiblesse. Une rupture due à un usage excessif est improbable.

C'est l'économie réalisée avec le système DreConnect qui convainc les professionnels! Outils de perçage DreConnect: Une seule longueur est suffisante!

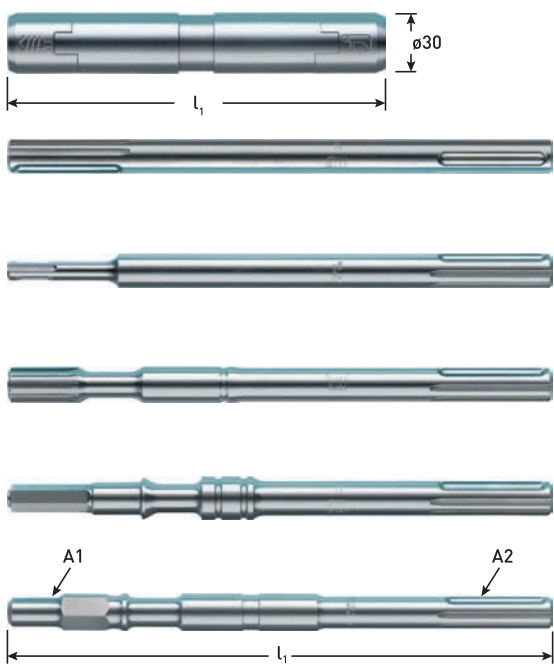

Nr.	A ₁	A ₂	l ₁	pcs/UD	Ref.	€/UD
1	SDS-max	SDS-max	190	1	209.0001	337,73
2	SDS-max	SDS-max	320	1	209.0010	42,97
2	SDS-max	SDS-max	750	1	209.0012	53,84
2	SDS-max	SDS-max	1100	1	209.0014	72,76
3	SDS-plus	SDS-max	320	1	209.0030	47,26
3	SDS-plus	SDS-max	750	1	209.0032	60,14
4	Cannelé droite	SDS-max	320	1	209.0040	53,28
4	Cannelé droite	SDS-max	750	1	209.0042	67,02
5	Hex. 13	SDS-max	750	1	209.0052	69,90
6	Hex. 19	SDS-max	750	1	209.0062	69,90

206

Foret à aspiration, SDS-plus



Exécution: Foret marteau SDS-plus (ø10mm) à aspiration de poussière intégrée. Fabriqué d'acier allié et des plaquettes carbure monobloc avec pointe de centrage spéciale le plus nouveau et PGM-certifiée avec des géométries innovants.

Livré avec un adaptateur monté

Application: Très convenable pour le perçage de béton et pierre, convenable pour béton armé et briques.

d ₁	l ₁	l ₂	pcs/UD	Ref.	€ / UD
12	330	200	1	206.1121	62,73
14	360	240	1	206.1141	65,95

d ₁	l ₁	l ₂	pcs/UD	Ref.	€ / UD
16	360	240	1	206.1161	69,44
18	360	240	1	206.1181	82,79

Foret à aspiration, SDS-max



Exécution: Foret marteau SDS-plus (ø18mm) à aspiration de poussière intégrée. Fabriqué d'acier allié et des plaquettes carbure à 4 taillants avec pointe de centrage spéciale le plus nouveau et PGM-certifiée avec des géométries innovants.

Livré avec un adaptateur monté

Application: Très convenable pour le perçage de béton et pierre, convenable pour béton armé et briques.

d ₁	l ₁	l ₂	pcs/UD	Ref.	€ / UD
16	600	400	1	206.6161	143,80
18	600	400	1	206.6181	150,20
20	600	400	1	206.6201	152,78
22	600	400	1	206.6221	155,99
24	600	400	1	206.6241	160,94
25	600	400	1	206.6251	162,08
28	600	400	1	206.6281	181,55

d ₁	l ₁	l ₂	pcs/UD	Ref.	€ / UD
28	900	700	1	206.6282	254,16
30	600	400	1	206.6301	187,95
30	900	700	1	206.6302	262,89
32	600	400	1	206.6321	196,36
32	900	700	1	206.6322	275,96
35	600	400	1	206.6351	202,18
35	900	700	1	206.6352	284,10

205

Tête de forage béton, SDS-max

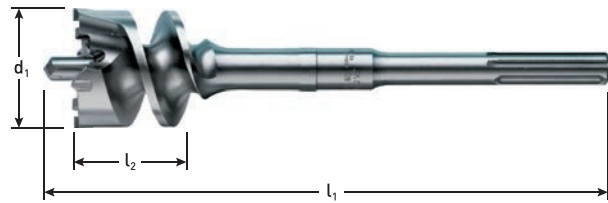

Exécution: Fabrication monobloc, avec foret centreur. Jusqu'à 30% plus rapide qu'un trepan en 2 pieces. Durée de vie largement accrue. Utilisable avec tous les perfos SDS-Max.

Fabriqués en Allemagne.

d ₁	l ₁	l ₂	pcs/UD	Ref.	€ / UD
40	310	80	1	205.4001	244,38
40	550	80	1	205.4002	302,04
45	550	80	1	205.4502	306,25
45	990	80	1	205.4503	363,33
55	550	80	1	205.5502	347,49

d ₁	l ₁	l ₂	pcs/UD	Ref.	€ / UD
55	990	80	1	205.5503	409,39
65	550	80	1	205.6502	380,44
65	990	80	1	205.6503	442,16
80	550	80	1	205.8002	422,94
80	990	80	1	205.8003	549,23

Exécution: Fabrication monobloc. Avec cône intérieur 1:8
Ne pas utiliser avec perforateurs > 10 kg

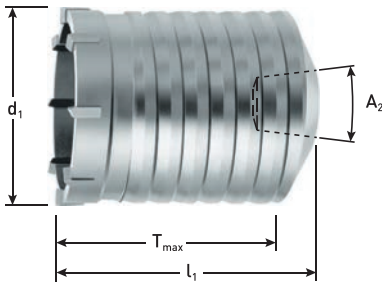

d ₁	l ₁	T _{max}	A ₂	pcs/UD	Ref.	€ / UD
35	100	75	1:8	1	207.0350	137,57
40	100	75	1:8	1	207.0400	145,13
45	100	75	1:8	1	207.0450	156,07
50	100	75	1:8	1	207.0500	160,96
60	100	75	1:8	1	207.0600	181,93
65	100	75	1:8	1	207.0650	197,48

d ₁	l ₁	T _{max}	A ₂	pcs/UD	Ref.	€ / UD
68	100	75	1:8	1	207.0680	237,39
80	100	75	1:8	1	207.0800	264,73
90	100	75	1:8	1	207.0900	287,81
100	100	75	1:8	1	207.1000	327,55
125	100	75	1:8	1	207.1250	404,15

Accessoires



d ₁	l ₁	A ₃	pcs/UD	Ref.	€ / UD
11	120	1:20	1	207.5002	13,49
10	150	1:20	1	207.5003	14,31
10	225	1:20	1	207.5005	19,53

Chasse-cône



Exécution: Chasse-cône selon DIN 317 pour cônes selon DIN 228 B, acier trempé et passivé.

Type	Convient à	l ₁	pcs/UD	Ref.	€ / UD
Nr. 1	CM 1 + 2	140	1	180.9001	11,31

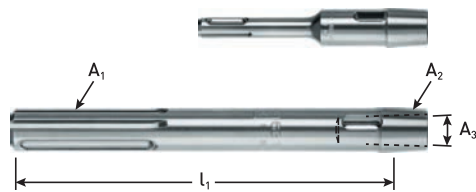

Nr.	A ₁	A ₂	A ₃	l ₁	pcs/UD	Ref.	€ / UD
1	SDS-plus	1:8	1:20	115	1	207.5006	56,52
2	SDS-max	1:8	1:20	180	1	207.5008	68,79
2	SDS-max	1:8	1:20	450	1	207.5009	106,78

Exécution: Emmanchement M16
Ne pas utiliser avec perforateurs > 4 kg

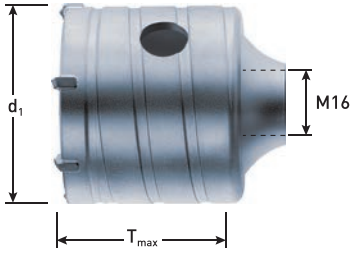

d ₁	T _{max}	pcs/UD	Ref.	€ / UD
30	50	1	208.0300	74,78
35	50	1	208.0350	84,09
40	50	1	208.0400	87,31
45	50	1	208.0450	88,87
50	50	1	208.0500	91,19
65	50	1	208.0650	92,47

d ₁	T _{max}	pcs/UD	Ref.	€ / UD
68	50	1	208.0680	97,12
80	50	1	208.0800	103,76
82	50	1	208.0820	109,74
100	50	1	208.1000	148,06
112	50	1	208.1120	196,66

Accessoires

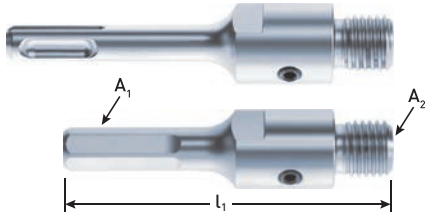

Nr.	A ₁	A ₂	l ₁	pcs/UD	Ref.	€ / UD
1	SDS-plus (ø10mm)	M16 (ext.)	105	1	208.5006	32,46
1	SDS-plus (ø10mm)	M16 (ext.)	220	1	208.5007	46,98
1	SDS-plus (ø10mm)	M16 (ext.)	350	1	208.5008	66,70
2	Hex. 12	M16 (ext.)	220	1	208.5011	29,64



Description	d ₁	l ₁	pcs/UD	Ref.	€ / UD
Foret centreur HM	8,0	120	1	210.5008	7,22

220

Foret béton - SUPER, dans EV-pack



Exécution: Forets bétons haut de gamme ayant une tête de perçage unique avec un point de centrage et une spirale H pour une vitesse de perçage maximum et une plus grande durée d' utilisation. Diamètres plus de 13mm, avec queue réduite de ø13mm.
Fabriqués en Allemagne

Application: Pour matériaux durs tels que le béton, les blocs de béton cellulaire, la maçonnerie, la pierre naturelle, la pierre de synthèse, les plaques de céramique et le granite.

d ₁	l ₁	l ₂	pcs/UD	Ref.	€ / UD
3	70	40	1	220.0300	2,96
4	85	50	1	220.0400	3,14
5	85	50	1	220.0500	3,25
5	150	115	1	220.0501	4,89
5,5 *	85	50	1	220.0550	3,31
6	100	60	1	220.0600	3,29
6	150	115	1	220.0601	5,42
7	100	60	1	220.0700	3,86
7*	150	115	1	220.0701	6,16
8	120	80	1	220.0800	4,32
8	200	160	1	220.0801	6,71

d ₁	l ₁	l ₂	pcs/UD	Ref.	€ / UD
10	120	80	1	220.1000	5,85
10	200	160	1	220.1001	9,17
10*	400	360	1	220.1002	11,02
12	150	110	1	220.1200	8,37
12	200	160	1	220.1201	11,67
14	150	110	1	220.1400	11,38
14*	600	560	1	220.1403	22,85
15*	150	115	1	220.1500	14,06
16	150	110	1	220.1600	15,59
22*	400	360	1	220.2201	42,87

* Article expiré, disponible jusqu'à épuisement des stocks

900

Jeu de forets béton - SUPER, dans cassette en métal



Exécution: Forets bétons haut de gamme ayant une tête de perçage unique avec un point de centrage et une spirale H pour une vitesse de perçage maximum et une plus grande durée d' utilisation.
Fabriqués en Allemagne

Application: Pour matériaux durs tels que le béton, les blocs de béton cellulaire, la maçonnerie, la pierre naturelle, la pierre de synthèse, les plaques de céramique et le granite.

Description	Type	Contenu	pcs/UD	Ref.	€ / UD
7 pcs - jeu de forets béton - super	220	ø4, 5, 8, 10 et 12 / 1 pc de chaque ø6 / 2 pcs	1	900.1005	38,17

225

Foret marteaux, dans EV-pack

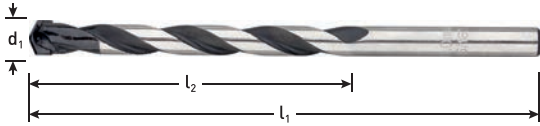

Exécution: Forets marteaux, queue cylindrique, les goujures demi-ronde garantissent l'évacuation optimisée des débris. Pour toutes les applications en brique, en pierre et en pierre naturelle.

d ₁	l ₁	l ₂	pcs/UD	Ref.	€ / UD
3	60	30	1	225.0300	1,59
4	75	40	1	225.0400	1,59
5	85	50	1	225.0500	1,70
6	100	60	1	225.0600	1,84
6	400	300	1	225.0602	7,63
7	100	60	1	225.0700	1,87
8	120	80	1	225.0800	2,27
8	400	300	1	225.0802	7,95
8*	600	450	1	225.0803	15,61
9	120	80	1	225.0900	2,73
10	120	80	1	225.1000	2,97
10	400	300	1	225.1002	9,08

d ₁	l ₁	l ₂	pcs/UD	Ref.	€ / UD
11	150	85	1	225.1100	3,85
12	150	85	1	225.1200	4,55
12	400	300	1	225.1202	9,59
14	150	95	1	225.1400	4,75
14	400	300	1	225.1401	13,44
16	150	95	1	225.1600	6,47
16	400	300	1	225.1601	16,97
18	400	300	1	225.1801	19,68
20	160	105	1	225.2000	10,67
20	400	300	1	225.2001	24,97
22	160	100	1	225.2200	9,43
22	400	300	1	225.2201	32,16

* Article expiré, disponible jusqu'à épuisement des stocks

900

Jeu de forets marteaux, dans cassette en PVC



Exécution: Forets marteaux, queue cylindrique, les goujures demi-ronde garantissent l'évacuation optimisée des débris. Pour toutes les applications en brique, en pierre et en pierre naturelle.

Description	Type	Contenu	pcs/UD	Ref.	€ / UD
5 pcs - jeu de forets marteaux	225	ø4, 5, 6, 8 et 10 / 1 pc de chaque	1	900.1040	9,66

Jeu de forets type '100', '225' et '235' dans cassette de ABS



Exécution: Jeu de forets pour le métal (type '100'), le bois (type '235') et la pierre (type '225') dans un cassette en ABS.

Description	Type	Contenu	pcs/UD	Ref.	€ / UD
18 pcs - jeu de forets combi	100	ø3, 4, 5, 6, 8 et 10mm / 1 pc de chaque	1	900.1059	32,71
	225	ø3, 4, 5, 6, 8 et 10mm / 1 pc de chaque			
	235	ø3, 4, 5, 6, 8 et 10mm / 1 pc de chaque			

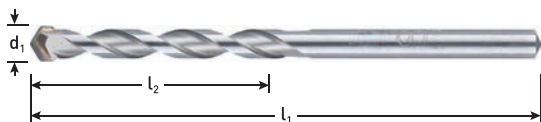

Exécution: Ces forets au carbure percent le métal, le bois et la pierre en «Mode rotation seule» uniquement. Ne pas utiliser le «mode percussion» avec ces forets. Convient pour percer des matériaux différents en une seule passe.

d_1	l_1	l_2	pcs/UD	Ref.	€/ UD
3	70	40	1	226.0300	5,68
4	75	40	1	226.0400	5,57
5	85	45	1	226.0500	5,47
6	100	50	1	226.0600	5,83
6	150	90	1	226.0601	6,38
6	200	140	1	226.0602	7,46
8	120	70	1	226.0800	6,61

d_1	l_1	l_2	pcs/UD	Ref.	€/ UD
8	260	200	1	226.0801	8,18
10	120	70	1	226.1000	7,46
10	260	200	1	226.1001	9,48
12	150	90	1	226.1200	10,29
12	260	200	1	226.1201	11,58
14	260	200	1	226.1400	15,85

226

Foret Multi-Matériaux - UNIDre

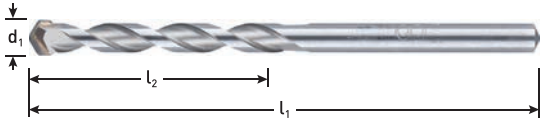

Exécution: Ces forets au carbure percent le métal, le bois et la pierre en «Mode rotation seule» uniquement. Ne pas utiliser le «mode percussion» avec ces forets. Convient pour percer des matériaux différents en une seule passe.

d ₁	l ₁	l ₂	pcs/UD	Ref.	€ / UD
3	70	40	10	226.3030	51,20
4	75	40	10	226.3040	50,20
5	85	45	10	226.3050	49,30
6	100	50	10	226.3060	52,50

d ₁	l ₁	l ₂	pcs/UD	Ref.	€ / UD
8	120	70	10	226.3080	59,50
10	120	70	10	226.3100	67,20
12	150	90	10	226.3120	92,70

900

Jeu de forets UNIDre, dans cassette en métal



Exécution: Ces forets au carbure percent le métal, le bois et la pierre en «Mode rotation seule» uniquement. Ne pas utiliser le «mode percussion» avec ces forets. Convient pour percer des matériaux différents en une seule passe.

Description	Type	Contenu	pcs/UD	Ref.	€ / UD
7 pcs - jeu de forets UNIDre	226	ø4, 5, 8, 10 et 12 / 1 pc de chaque ø6 / 2 pcs	1	900.1006	55,83

226

Foret Multi-Matériaux - UNIDre, queue six-pans 1/4" (E6.3), dans EV-pack

ROTEC®

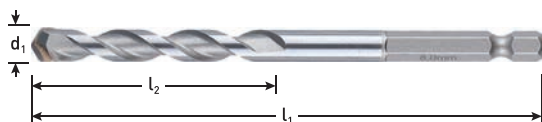

Exécution: Embouts de perçage, queue six pans (1/4") selon DIN 3126-E6.3 (ISO 1173).

Application: Ces forets au carbure percent le métal, le bois et la pierre en «Mode rotation seule» uniquement. Ne pas utiliser le «mode percussion» avec ces forets. Convient pour percer des matériaux différents en une seule passe.

Fabriqués en Allemagne

d ₁	l ₁	l ₂	pcs/UD	Ref.	€ / UD
4	90	45	1	226.6040	7,03
5	100	50	1	226.6050	7,15
6	100	50	1	226.6060	7,46
8	120	60	1	226.6080	10,07
10	120	60	1	226.6100	10,90

226

Foret Multi-Matériaux - UNIDre, queue six-pans 1/4" (E6.3)

ROTEC®

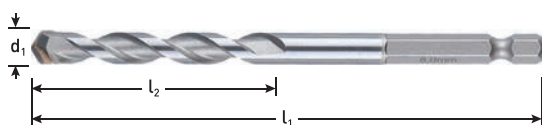

Exécution: Embouts de perçage, queue six pans (1/4") selon DIN 3126-E6.3 (ISO 1173).

Application: Ces forets au carbure percent le métal, le bois et la pierre en «Mode rotation seule» uniquement. Ne pas utiliser le «mode percussion» avec ces forets. Convient pour percer des matériaux différents en une seule passe.

Fabriqués en Allemagne

d ₁	l ₁	l ₂	pcs/UD	Ref.	€ / UD
4	90	45	10	226.8040	63,30
5	100	50	10	226.8050	64,40
6	100	50	10	226.8060	67,20
8	120	60	10	226.8080	90,70
10	120	60	10	226.8100	98,10

900

Jeu de forets UNIDre, queue six-pans 1/4" (E6.3), dans cassette en ABS

ROTEC®



Exécution: Embouts de perçage, queue six pans (1/4") selon DIN 3126-E6.3 (ISO 1173).

Application: Ces forets au carbure percent le métal, le bois et la pierre en «Mode rotation seule» uniquement. Ne pas utiliser le «mode percussion» avec ces forets. Convient pour percer des matériaux différents en une seule passe.

Fabriqués en Allemagne

Description	Type	Contenu	pcs/UD	Ref.	€ / UD
4 pcs - jeu de forets UNIDre	226	ø4, 5, 6 et 8 / 1 pc de chaque	1	900.1008	31,71

228

Foret de carrelage Extreme, dans EV-pack

ROTEC®

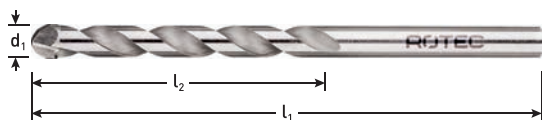

Exécution: Foret de carrelage "Extrême" avec la pointe carbure aiguisé extrêmement. Ne pas utiliser le «mode percussion» avec ces forets.

Fabriqués en Allemagne

d ₁	l ₁	l ₂	pcs/UD	Ref.	€ / UD
4	85	50	1	228.0400	22,77
5	85	50	1	228.0500	24,15
6	100	65	1	228.0600	25,28
8	125	75	1	228.0800	31,37
10	150	90	1	228.1000	38,14



Exécution: Forets avec mise carbure rapportée, affûtée en pointe. Conçus pour verre, carrelage, miroirs et céramique.

Fabriqués en Allemagne.

d ₁	l ₁	pcs/UD	Ref.	€ / UD
3,0	58	1	229.0300	5,89
4,0	64	1	229.0400	7,34
5,0	70	1	229.0500	7,77
6,0	76	1	229.0600	8,36
8,0	83	1	229.0800	11,07
10,0	90	1	229.1000	12,69
12,0	97	1	229.1200	15,59

214

Burins, SDS-plus, OPTI-LINE

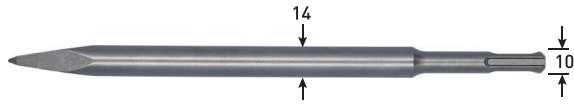

Description	B (mm)	L (mm)	pcs/UD	Ref.	€ / UD
Burin pointé	-	250	1	214.0005	10,95

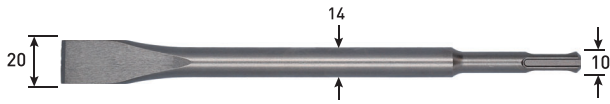

Description	B (mm)	L (mm)	pcs/UD	Ref.	€ / UD
Burin plat	20	250	1	214.0010	10,95

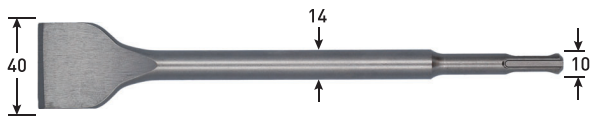

Description	B (mm)	L (mm)	pcs/UD	Ref.	€ / UD
Bêche	40	250	1	214.0015	14,95



SDS-plus Jeu de burins, OPTI-LINE



Description	Contenu	pcs/UD	Ref.	€ / UD
3 pcs - jeu de burins SDS-plus, OPTI-LINE	1x Burin pointé, 250 mm 1x Burin plat, 20x250 mm 1x Burin bêche, 40x250 mm	1	214.9000	29,95

NEXT GENERATION

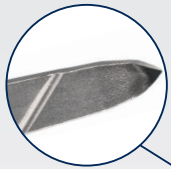

Maximized production
Optimized transfer of power to the tip of the chisel, work can be done more efficient, faster and without unwanted stops.

SDS-plus
Pointed chisel
Tool life +200%

Longer working area
These new generation chisels are made with a longer working area that contributes considerably to a longer tool life without re-sharpening.

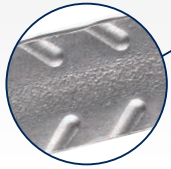

Optimized design
Thanks to the new and optimized design friction is reduced and the chance of getting stuck is minimized.

SDS-plus
Flat chisel
Tool life +115%

The new "V-Breaker" chisel is a top of the line PREMIUM product. Thanks to the self sharpening properties, no valuable time is lost on re-sharpening and a high and constant level of production are guaranteed.

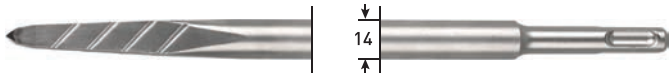

Exécution: Burins nouveaux 'V-Breaker'

Description	B (mm)	L (mm)	pcs/UD	Ref.	€ / UD
Burin pointé 'V-Breaker'	-	250	1	215.0106	20,94

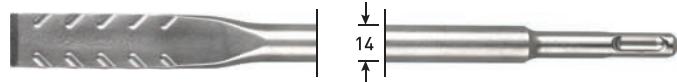

Exécution: Burins nouveaux 'V-Breaker'

Description	B (mm)	L (mm)	pcs/UD	Ref.	€ / UD
Burin plat 'V-Breaker'	20	250	1	215.0111	20,94

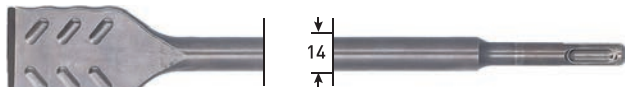

Exécution: Burins nouveaux 'V-Breaker'

Description	B (mm)	L (mm)	pcs/UD	Ref.	€ / UD
Burin bêche 'V-Breaker'	40	250	1	215.0115	29,98

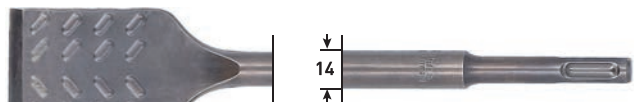

Exécution: Burins nouveaux 'V-Breaker'

Description	B (mm)	L (mm)	pcs/UD	Ref.	€ / UD
Ciseau à carreaux 'V-Breaker'	50	250	1	215.0116	43,89
Ciseau à carreaux 'V-Breaker'	75	165	1	215.0118	35,23

Burins, SDS-plus

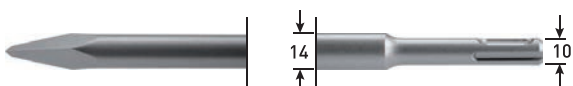

Description	B (mm)	L (mm)	pcs/UD	Ref.	€ / UD
Burin pointé	-	250	1	215.0005	13,08

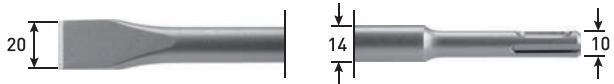

Description	B (mm)	L (mm)	pcs/UD	Ref.	€ / UD
Burin plat	20	250	1	215.0010	13,08



Description	B (mm)	L (mm)	pcs/UD	Ref.	€ / UD
Bêche	40	250	1	215.0015	21,61



Description	B (mm)	L (mm)	pcs/UD	Ref.	€ / UD
Bêche courbé	40	250	1	215.0016	23,03



Description	B (mm)	L (mm)	pcs/UD	Ref.	€ / UD
Carrelage	60	250	1	215.0017	60,49

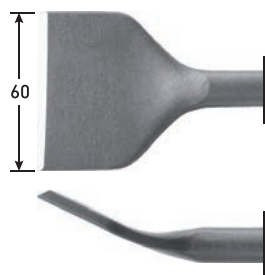

Description	B (mm)	L (mm)	pcs/UD	Ref.	€ / UD
Carrelage, courbé	60	250	1	215.0018	62,88

Application: Pour réaliser des canaux étroits dans le béton.

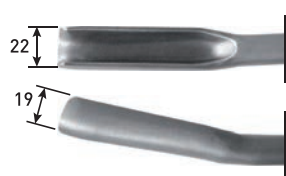

Description	B (mm)	L (mm)	pcs/UD	Ref.	€ / UD
Gouge	22	250	1	215.0020	41,78

Exécution: Pour les travaux dans le grès, la brique et la pierre.

Application: Idéal pour faire varier profondeur du canal grâce aux joues de guidage et pour creuser des emplacements pour boîtes de distribution ou prises de courant sans changer d'outils.

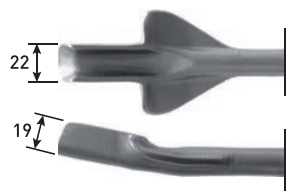

Description	B (mm)	L (mm)	pcs/UD	Ref.	€ / UD
Gouge à joues de guidage	22	250	1	215.0025	82,42

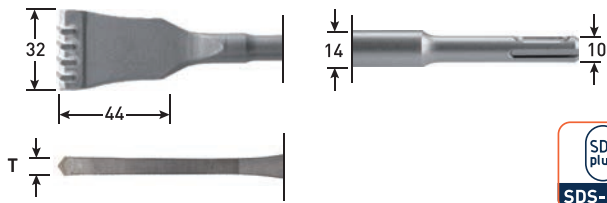

Exécution: Burin plat denté en carbure de tungstène pour le parement des surfaces en béton. Ce burin n'est pas destiné à enlever les briques (intactes) et/ou les joints. Pour les burins à joints, voir le groupe '216'. En ce qui concerne la durée de vie de l'outil, ce burin est sans garantie.

Description	T	B (mm)	L (mm)	pcs/UD	Ref.	€ / UD
Burin à 'Façades' au carbure	10	32	125	1	215.0030	164,16

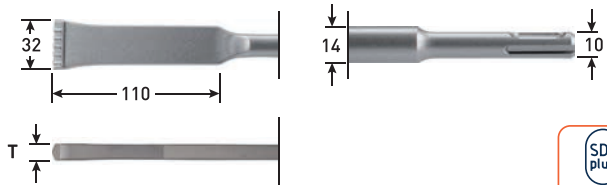

Exécution: Burin plat denté en carbure de tungstène pour le parement des surfaces en béton. Ce burin n'est pas destiné à enlever les briques (intactes) et/ou les joints. Pour les burins à joints, voir le groupe '216'. En ce qui concerne la durée de vie de l'outil, ce burin est sans garantie.

Description	T	B (mm)	L (mm)	pcs/UD	Ref.	€ / UD
Burin à 'Façades' au carbure	10	32	200	1	215.0035	164,16

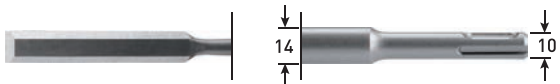

Application: Travail rapide dans le bois tendre.

Description	B (mm)	L (mm)	pcs/UD	Ref.	€ / UD
Ciseau à bois	10	165	1	215.0040	57,64
Ciseau à bois	20	175	1	215.0050	61,96
Ciseau à bois	30	170	1	215.0060	91,28

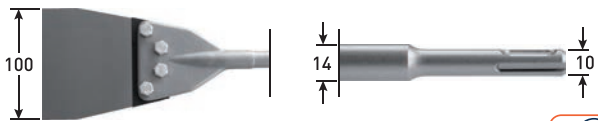

Exécution: Scraper avec une lame remplaçable. Le kit se compose d'une lame et les écrous et boulons associé.

Application: Pour enlever les restes de colle, les revêtements de sol (tapis, pvc, etc...).

Description	B (mm)	L (mm)	pcs/UD	Ref.	€ / UD
Scraper	100	250	1	215.0065	350,45
Kit de remplacement	100		1	215.0066	48,91

SDS-plus Jeu de burins



Application: Modèle court pour les petits espaces

Description	Contenu	pcs/UD	Ref.	€ / UD
3 pcs - jeu de burins SDS-plus en cas plastique	1x burin pointé x 140 1x burin plat 20 x 140 1x burin bêche 30 x 140	1	215.0100	35,90

NEXT GENERATION

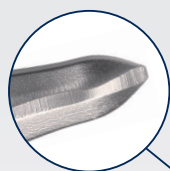

Maximized production
Optimized transfer of power to the tip of the chisel, work can be done more efficient, faster and without unwanted stops.

SDS-max
Pointed chisel
**Tool life
+170%**

Longer working area
These new generation chisels are made with a longer working area that contributes considerably to a longer tool life without re-sharpening.



Optimized design
Thanks to the new and optimized design friction is reduced and the chance of getting stuck is minimized.

SDS-max
Flat chisel
**Tool life
+125%**

The new "V-Breaker" chisel is a top of the line PREMIUM product. Thanks to the self sharpening properties, no valuable time is lost on re-sharpening and a high and constant level of production are guaranteed.

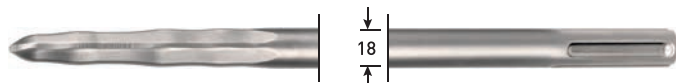

Exécution: Burins nouveaux 'V-Breaker'

Description	B (mm)	L (mm)	pcs/UD	Ref.	€ / UD
Burin pointé 'V-Breaker'	-	280	1	215.1105	32,39
Burin pointé 'V-Breaker'	-	400	1	215.1108	34,96

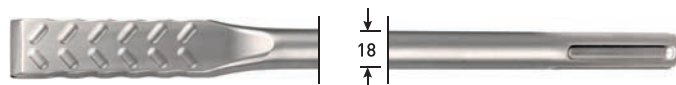

Exécution: Burins nouveaux 'V-Breaker'

Description	B (mm)	L (mm)	pcs/UD	Ref.	€ / UD
Plat 'V-Breaker'	25	280	1	215.1113	32,39
Plat 'V-Breaker'	25	400	1	215.1112	34,96



Exécution: Burins nouveaux 'V-Breaker'

Description	B (mm)	L (mm)	pcs/UD	Ref.	€ / UD
Burin bêche 'V-Breaker'	50	380	1	215.1115	47,54



Exécution: Burins nouveaux 'V-Breaker'

Description	B (mm)	L (mm)	pcs/UD	Ref.	€ / UD
Ciseau à carreaux 'V-Breaker'	50	380	1	215.1116	59,79

Burins, SDS-max

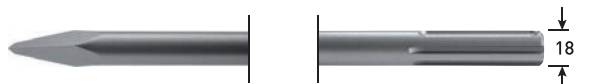

Description	B (mm)	L (mm)	pcs/UD	Ref.	€ / UD
Burin pointé	-	280	1	215.1005	18,57
Burin pointé	-	400	1	215.1006	20,35
Burin pointé	-	600	1	215.1007	27,92

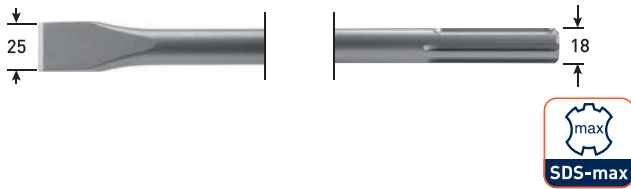

Description	B (mm)	L (mm)	pcs/UD	Ref.	€ / UD
Plat	25	280	1	215.1010	18,57
Plat	25	400	1	215.1011	20,35
Plat	25	600	1	215.1012	27,92

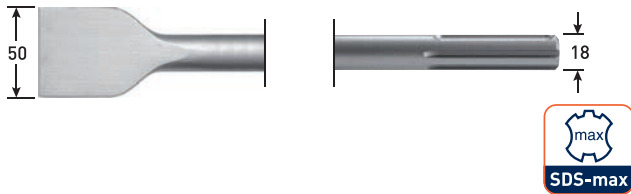

Description	B (mm)	L (mm)	pcs/UD	Ref.	€ / UD
Burin bêche	50	360	1	215.1015	33,88

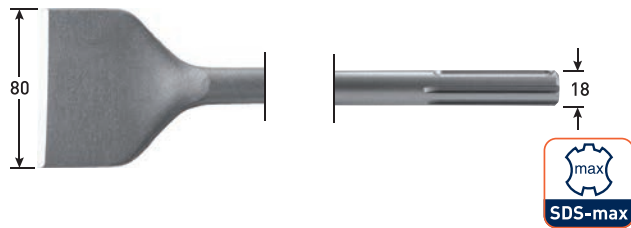

Description	B (mm)	L (mm)	pcs/UD	Ref.	€ / UD
Burin carrelage	80	300	1	215.1017	42,24

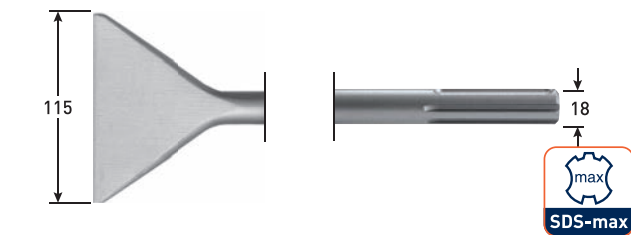

Description	B (mm)	L (mm)	pcs/UD	Ref.	€ / UD
Burin carrelage	115	350	1	215.1018	127,07

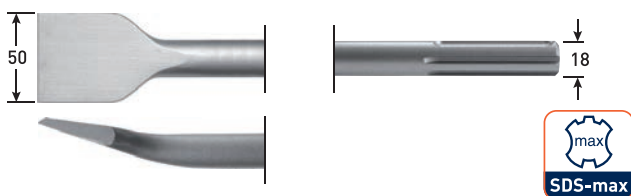

Description	B (mm)	L (mm)	pcs/UD	Ref.	€ / UD
Bêche, courbé	50	300	1	215.1025	59,85

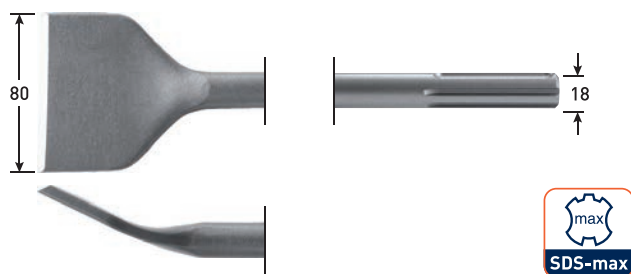

Description	B (mm)	L (mm)	pcs/UD	Ref.	€ / UD
Burin carrelage, courbé	80	300	1	215.1027	49,83

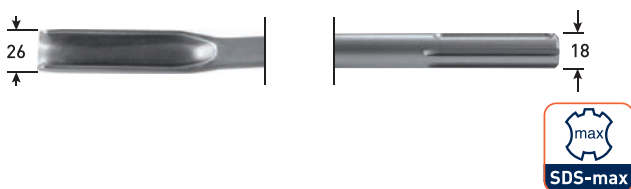

Application: Coupe facile de canaux étroits dans le béton.

Description	B (mm)	L (mm)	pcs/UD	Ref.	€ / UD
Burin gouge creuse	26	300	1	215.1045	46,44



Application: Coupe facile de rainures étroites dans la brique.

Description	B (mm)	L (mm)	pcs/UD	Ref.	€ / UD
Burin gouge	32	300	1	215.1050	81,53



Exécution: Coupe de rainures étroites dans le béton et la brique, différentes profondeurs.

Application: Idéal pour faire varier profondeur du canal grâce aux joues de guidage et pour creuser des emplacements pour boîtes de distribution ou prises de courant sans changer d'outils.

Description	B (mm)	L (mm)	pcs/UD	Ref.	€ / UD
Gouge à joues de guidage	35	380	1	215.1055	176,40

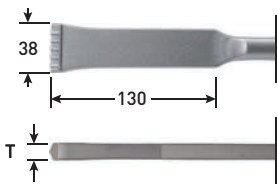

Exécution: Pour déjoindre, enlever sans abîmer les briques ou les pierres de maçonnerie enlever, le carrelage et les couches de crépi. Aucune garantie quant à la durabilité.

Description	T	B (mm)	L (mm)	pc/UD	Ref.	€ / UD
Façade au carbure	10	38	280	1	215.1060	191,70



Application: Pour la construction des routes et les travaux dans les sols fermes. Pour assainissement de surface à asphalté. Ne pas utiliser sur du béton!

Description	B (mm)	L (mm)	pcs/UD	Ref.	€ / UD
Couteau à asphalté	90	400	1	215.1070	124,53



Application: Pour les travaux généraux de jardinage et agricole, creusement dans l'argile, les sols gravilloneux et la boue. Ne pas utiliser sur du béton!

Description	B (mm)	L (mm)	pcs/UD	Ref.	€ / UD
Burin pelle	110	400	1	215.1075	147,14



Application: Pour les travaux généraux de jardinage et agricole, creusement dans l'argile, les sols gravilloneux, et la boue, pour les travaux routiers. Ne pas utiliser sur du béton!

Description	B (mm)	L (mm)	pcs/UD	Ref.	€ / UD
Burin bêche arrondi	135	400	1	215.1030	194,00



Application: Polissage de la pierre, du béton et de l'asphalte.

Description	B (mm)	L (mm)	pcs/UD	Ref.	€ / UD
Boucharde	45x45	240	1	215.1080	195,17

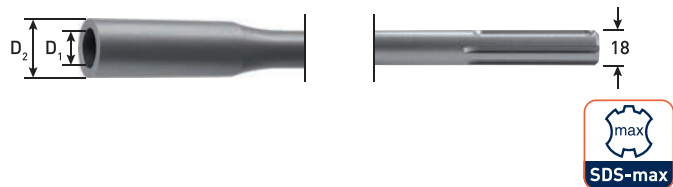

Application: Pour enfoncer à la machine des objets en terre par exemple des paratonnerres.

Description	D ₁	D ₂	L (mm)	pc/UD	Ref.	€ / UD
Enfonceur	13	26	260	1	215.1085	99,50
Enfonceur	16.5	26	260	1	215.1087	99,50

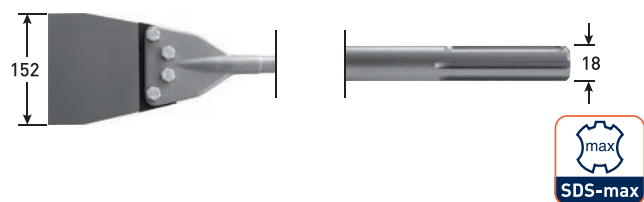

Exécution: Scrapper avec une lame remplaçable.
Le kit se compose d'une lame et les écrous et boulons associé.

Application: Pour enlever les restes de colle, les revêtements de sol (tapis, pvc, etc...).

Description	B (mm)	L (mm)	pcs/UD	Ref.	€ / UD
Burin scrapper	152	630	1	215.1090	503,00
Kit de remplacement	152		1	215.1091	124,57

Burins, hex. 19mm / ø16,5x35

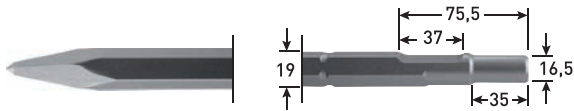

Description	B (mm)	L (mm)	pcs/UD	Ref.	€ / UD
Burin pointé	-	300	1	215.3005	30,36
Burin pointé	-	400	1	215.3006	37,38

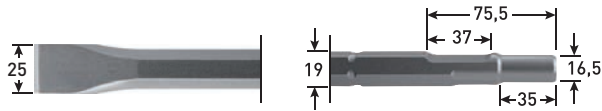

Description	B (mm)	L (mm)	pcs/UD	Ref.	€ / UD
Burin plat	25	300	1	215.3010	29,81
Burin plat	25	400	1	215.3011	35,39
Burin plat	25	450	1	215.3012	37,02

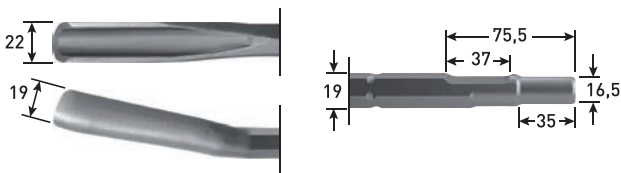

Application: Pour réaliser des canaux étroits dans le béton.

Description	B (mm)	L (mm)	pcs/UD	Ref.	€ / UD
Burin gouge creuse	22	250	1	215.3015	43,14

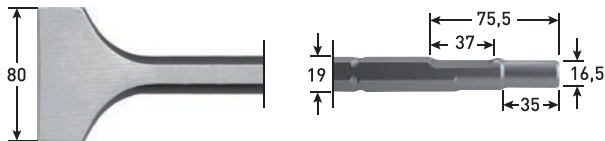

Description	B (mm)	L (mm)	pcs/UD	Ref.	€ / UD
Burin carrelage	80	300	1	215.3040	69,34

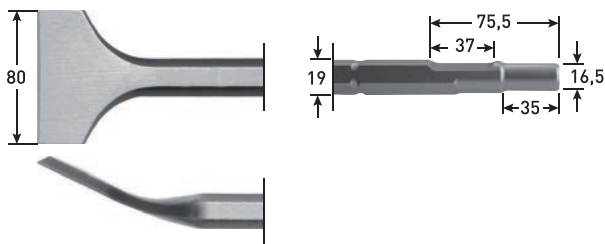

Description	B (mm)	L (mm)	pcs/UD	Ref.	€ / UD
Burin carrelage, courbé	80	300	1	215.3045	67,98

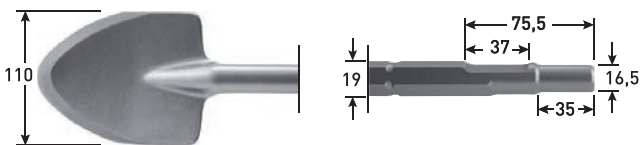

Application: Pour les travaux généraux de jardinage et agricole, creusement dans l'argile, les sols gravillonneux et la boue. Ne pas utiliser sur du béton!

Description	B (mm)	L (mm)	pcs/UD	Ref.	€ / UD
Burin bêche arrondi	115	350	1	215.3065	169,08

Burins, hex. 19mm / avec plat

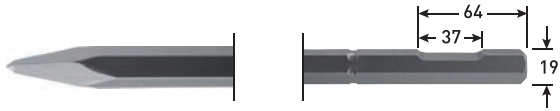

Description	B (mm)	L (mm)	pcs/UD	Ref.	€ / UD
Burin pointé	-	400	1	215.3506	29,73
Burin pointé	-	600	1	215.3507	40,60

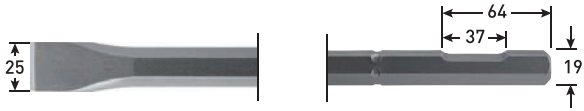

Description	B (mm)	L (mm)	pcs/UD	Ref.	€ / UD
Burin plat	25	400	1	215.3511	32,16
Burin plat	25	600	1	215.3512	41,49

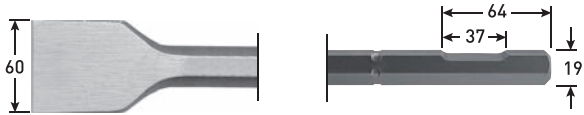

Description	B (mm)	L (mm)	pcs/UD	Ref.	€ / UD
Bêche	60	450	1	215.3521	75,04

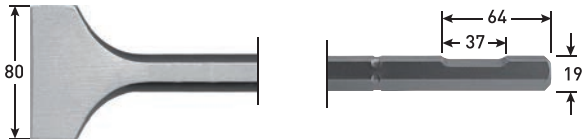

Description	B (mm)	L (mm)	pcs/UD	Ref.	€ / UD
Burin carrelage	80	300	1	215.3525	51,52

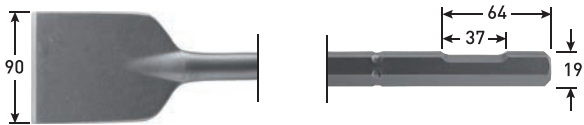

Description	B (mm)	L (mm)	pcs/UD	Ref.	€ / UD
Couteau à asphalte	90	400	1	215.3535	146,05

Application: Pour la construction des routes et les travaux dans les sols fermes. Pour assainissement de surface à asphalte. Ne pas utiliser sur du béton!

Burins, hex. 21mm / ø19x61

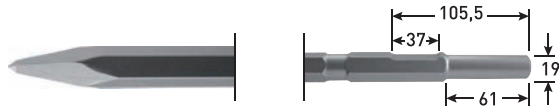

Description	B (mm)	L (mm)	pcs/UD	Ref.	€ / UD
Burin pointé	-	300	1	215.4005	36,48
Burin pointé	-	380	1	215.4006	42,33
Burin pointé	-	460	1	215.4007	45,84
Burin pointé	-	600	1	215.4008	55,42



Description	B (mm)	L (mm)	pcs/UD	Ref.	€ / UD
Burin plat	25	380	1	215.4011	43,50
Burin plat	25	460	1	215.4012	47,01
Burin plat	25	600	1	215.4013	58,06

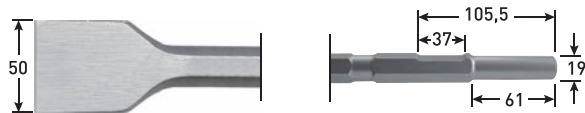

Description	B (mm)	L (mm)	pcs/UD	Ref.	€ / UD
Bêche	50	300	1	215.4015	51,12

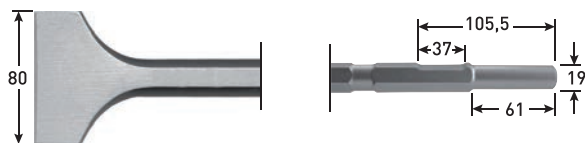

Description	B (mm)	L (mm)	pcs/UD	Ref.	€ / UD
Bêche	75	300	1	215.4020	65,65

Burins, hex. 17mm / ø13x45



Description	B (mm)	L (mm)	pcs/UD	Ref.	€ / UD
Burin pointé	-	280	1	215.5005	14,58

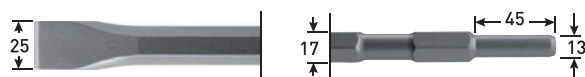

Description	B (mm)	L (mm)	pcs/UD	Ref.	€ / UD
Burin plat	25	280	1	215.5010	35,66
Burin plat	25	450	1	215.5011	44,67

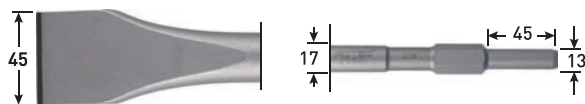

Description	B (mm)	L (mm)	pcs/UD	Ref.	€ / UD
Burin bêche	50	280	1	215.5020	59,58

Burins, hex. 30mm / ø24x55

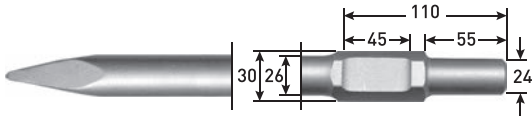

Description	B (mm)	L (mm)	pcs/UD	Ref.	€/ UD
Burin pointé	-	400	1	215.5205	71,26

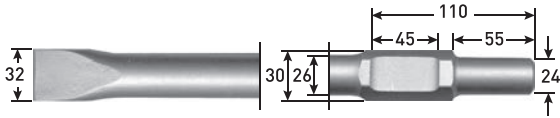

Description	B (mm)	L (mm)	pcs/UD	Ref.	€/ UD
Burin plat	32	400	1	215.5210	72,70

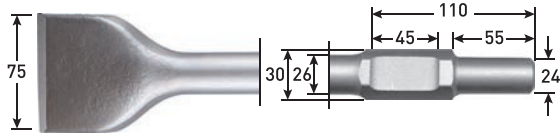

Description	B (mm)	L (mm)	pcs/UD	Ref.	€/ UD
Burin carrelage	75	400	1	215.5215	160,19

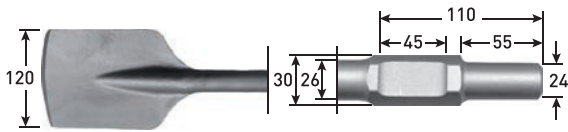

Application: Pour les travaux généraux de jardinage et agricole, creusement dans l'argile, les sols gravilloneux, et la boue, pour les travaux routiers. Ne pas utiliser sur du béton!

Description	B (mm)	L (mm)	pcs/UD	Ref.	€/ UD
Burin bêche arrondi	120	400	1	215.5220	187,01

Burins, hex. 28mm

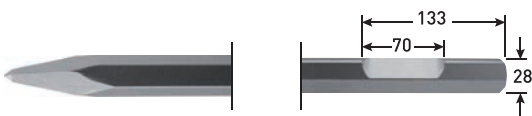

Description	B (mm)	L (mm)	pcs/UD	Ref.	€/ UD
Burin pointé	-	400	1	215.6005	66,22
Burin pointé	-	500	1	215.6010	82,78

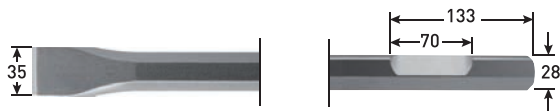

Description	B (mm)	L (mm)	pcs/UD	Ref.	€/ UD
Burin plat	35	400	1	215.6015	67,19
Burin plat	35	500	1	215.6016	84,05



Description	B (mm)	L (mm)	pcs/UD	Ref.	€/ UD
Burin bêche	80	400	1	215.6020	157,36

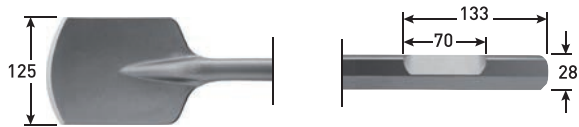

Application: Pour les travaux généraux de jardinage et agricole, creusement dans l'argile, les sols gravilloneux, et la boue, pour les travaux routiers. Ne pas utiliser sur du béton!

Description	B (mm)	L (mm)	pcs/UD	Ref.	€ / UD
Burin bêche arrondi	125	400	1	215.6025	181,10

Burins, hex. 22mm

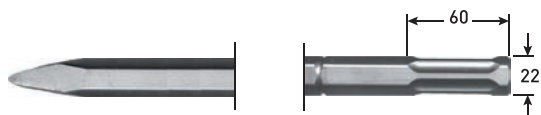

Description	B (mm)	L (mm)	pcs/UD	Ref.	€ / UD
Burin pointé	-	360	1	215.6505	77,52
Burin pointé	-	500	1	215.6506	93,85

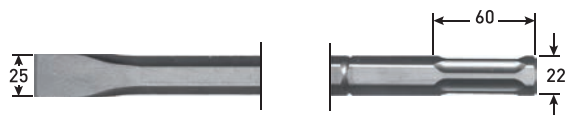

Description	B (mm)	L (mm)	pcs/UD	Ref.	€ / UD
Burin plat	25	360	1	215.6510	78,41



Description	B (mm)	L (mm)	pcs/UD	Ref.	€ / UD
Burin bêche	50	360	1	215.6515	125,91



Description	B (mm)	L (mm)	pcs/UD	Ref.	€ / UD
Burin carrelage	80	360	1	215.6517	176,92



B (mm)	l ₁	A (mm)	pcs/UD	Ref.	€/UD
-	200	14	1	218.0001	7,99
-	200	16	1	218.0003	7,99
-	300	16	1	218.0007	9,75
-	350	18	1	218.0011	12,86

Acier
45 CrMoV7

DIN
7256

Queue



Burin plat pour maçonnerie, octogonal



B (mm)	l ₁	A (mm)	pcs/UD	Ref.	€/UD
20	200	14	1	218.0101	7,54
23	200	16	1	218.0103	8,51
23	300	16	1	218.0107	10,34
26	400	18	1	218.0113	14,49

Acier
45 CrMoV7

DIN
7254B

Queue



Burin plat pour la pierre, plat



B (mm)	l ₁	SxW (mm)	pcs/UD	Ref.	€/UD
25	200	20x12	1	218.0201	8,36
25	250	20x12	1	218.0203	9,06
28	300	23x13	1	218.0205	11,28
28	400	23x13	1	218.0209	14,11

Acier
45 CrMoV7

DIN
7254A

Queue

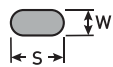

Burin à métaux, plat



B (mm)	l ₁	SxW (mm)	pcs/UD	Ref.	€/UD
15	125	14x9	1	218.0303	5,95
18	150	17x11	1	218.0305	6,54
21	175	20x12	1	218.0307	7,33
24	200	23x13	1	218.0309	8,24
25	250	23x13	1	218.0311	9,75
26	300	23x13	1	218.0313	11,72
32	400	26x13	1	218.0315	16,34

Acier
45 CrMoV7

DIN
6453

Queue

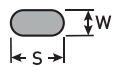

Burin à rainurer



B (mm)	l ₁	A (mm)	SxW (mm)	pcs/UD	Ref.	€/UD
26	230		26x7	1	218.0501	9,38
26	240		26x7	1	218.0503	9,64
30	230	18		1	218.0505	14,20
30	300	18		1	218.0507	15,49

Acier
45 CrMoV7

Queue

Queue

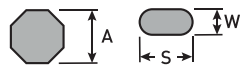

Burin pour les électriciens



B (mm)	l ₁	A (mm)	V (mm)	pcs/UD	Ref.	€ / UD
8	200		8	1	218.0601	5,66
10	200		8	1	218.0603	6,22
10	250		8	1	218.0605	6,85
14	250		10	1	218.0607	7,80
10	250	8		1	218.0611	5,38
12	250	10		1	218.0613	5,99
15	250	12		1	218.0615	6,69



Burin à métaux, octogonal



B (mm)	l ₁	A (mm)	pcs/UD	Ref.	€ / UD
10	100	8	1	218.0701	5,21
12	125	10	1	218.0703	5,31
16	150	12	1	218.0705	5,66
22	200	16	1	218.0709	7,65
26	250	18	1	218.0711	10,91

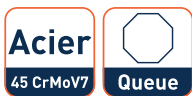

Ciseau à brique



B (mm)	l ₁	D (mm)	SxW (mm)	pcs/UD	Ref.	€ / UD
50	250		23x13	1	218.1101	14,97
60	230		20x12	1	218.1103	15,82
75	230		23x13	1	218.1105	16,60
100	250	25		1	218.1107	24,86

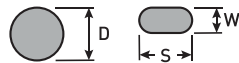

Protège-mains



A (mm)	SxW (mm)	Ref.	€ / UD
	26x7	218.1201	4,08
	23x13	218.1203	3,99
	20x12	218.1207	4,41
16		218.1204	4,41
18		218.1205	4,41

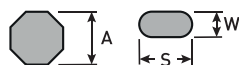



Description	Type	Contenu	pcs/UD	Ref.	€ / UD
jeu à 6 pcs - cassette métal	218	1x burin plat (125 et 150) 1x burin cruciforme (125) 1x chasse-pointe (120x2 et 150x4) 1x pointeau de centrage (120x10)	1	218.9001	35,49



Description	Type	Contenu	pcs/UD	Ref.	€ / UD
jeu à 6 pcs - cassette plastique	218	1x burin plat (125 et 150) 1x burin cruciforme (125) 1x chasse-pointe (120x2 et 150x4) 1x pointeau de centrage (120x10)	1	218.9005	32,60



Description	Type	Contenu	pcs/UD	Ref.	€ / UD
jeu à 6 pcs - porte outils en plastique	218	1x burin plat (125 et 150) 1x burin cruciforme (125) 1x chasse-pointe (120x2 et 150x4) 1x pointeau de centrage (120x10)	1	218.9007	32,52

219

Chasse-pointe



d ₁	l ₁	A (mm)	pcs/UD	Ref.	€ / UD
2	120	10	1	219.0001	3,84
3	120	10	1	219.0003	3,84
4	120	10	1	219.0005	3,84
5	120	10	1	219.0007	3,84
6	120	10	1	219.0009	3,84
7	120	12	1	219.0011	4,23

Acier
45 CrMoV7

DIN
6458

Queue



Jeu de chasses-pointes



Description	Type	Contenu	pcs/UD	Ref.	€ / UD
jeu à 6 pcs - porte outils en plastique	219	1x chasse-pointe ø2, 3, 4, 5 et 6 x 120 mm 1x pointe de centrage ø4 x 120 mm	1	219.0092	21,43



Description	Type	Contenu	pcs/UD	Ref.	€ / UD
jeu à 6 pcs - cassette métal	219	1x chasse-pointe ø2, 3, 4, 5 et 6 x 120 mm 1x pointe de centrage ø4 x 120 mm	1	219.0093	25,19



Description	Type	Contenu	pcs/UD	Ref.	€ / UD
jeu à 6 pcs - cassette plastique	219	1x chasse-pointe ø2, 3, 4, 5 et 6 x 120 mm 1x pointe de centrage ø4 x 120 mm	1	219.0094	25,39

Chasse-goupille



d ₁	l ₁	A (mm)	pcs/UD	Ref.	€ / UD
2	150	10	1	219.1001	5,66
3	150	10	1	219.1003	5,66
4	150	10	1	219.1005	5,66
5	150	10	1	219.1007	5,66
6	150	10	1	219.1009	5,66
8	150	10	1	219.1013	5,94
8	150	12	1	219.1015	6,42



Jeu de chasses-goupilles



Description	Type	Contenu	pcs/UD	Ref.	€ / UD
jeu à 6 pcs - porte outils en plastique	219	1x chasse-goupilles ø3, 4, 5, 6, 7 et 8 x 150 mm	1	219.1092	29,20



Description	Type	Contenu	pcs/UD	Ref.	€ / UD
jeu à 6 pcs - cassette métal	219	1x chasse-goupilles ø3, 4, 5, 6, 7 et 8 x 150 mm	1	219.1093	43,56



Description	Type	Contenu	pcs/UD	Ref.	€ / UD
jeu à 6 pcs - cassette plastique	219	1x chasse-goupilles ø3, 4, 5, 6, 7 et 8 x 150 mm	1	219.1094	40,19

Pointeau de centrage



d ₁	l ₁	A (mm)	pcs/UD	Ref.	€ / UD
4	120	10	1	219.2001	4,00
5	120	12	1	219.2003	4,36

Acier
45 CrMoV7

DIN
7250

Queue



Pied-de-biche

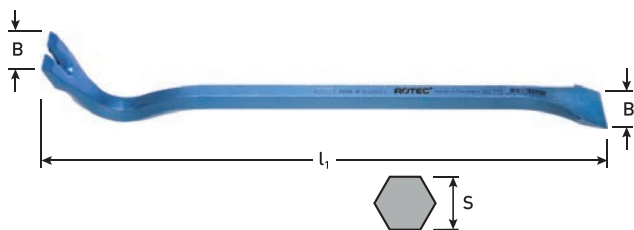

B (mm)	l ₁	S	pcs/UD	Ref.	€ / UD
32	400	18	1	219.3001	14,39
32	500	18	1	219.3003	15,04
32	600	18	1	219.3005	16,18
32	800	18	1	219.3007	20,45
32	1000	18	1	219.3009	24,27

